

Single Control Widespread Faucet

TECK[®]
COMMERCIAL

DELTA[®]

SPECIFICATION: (EXAMPLE)

- Widespread single control faucet
- 102 to 406mm (4" to 16") adjustable centers
- Polished chrome-plated finish
- **Delta**[®] washerless stainless steel ball
- Handle rotation limit stop
- 3/8" IPS **BRASS PIPE** Rigid/Swivel Gooseneck spout
- Metal trim, colour indexed vandal resistant lever blade handle and ... with... (add product variation required)
with... (add outlet required)

24T2643





Engineer/Architect Approval	
Model Specified:	
Approval:	Date:

MODEL NUMBER EXAMPLE:

Configurations vary, see below for availability.

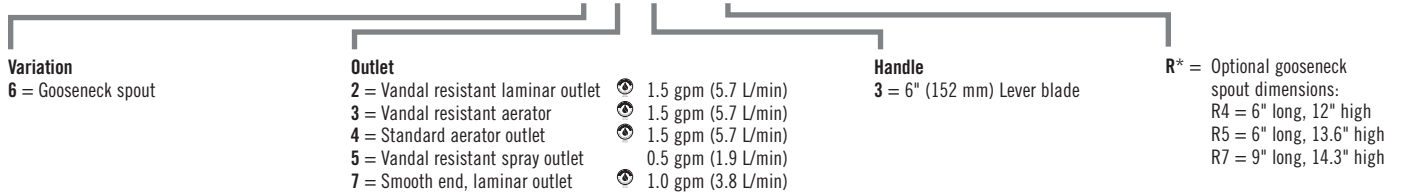
24T2623-R4



AVAILABLE MODELS	VARIATIONS	
	Control Unit ONLY	6
3 Lever 6" (152 mm)	 24T0003	 Gooseneck R2 Spout 4.5" (114 mm) long, 12.1" (308 mm) high 24T2623 24T2623-R4 24T2623-R5 24T2633 24T2633-R4 24T2633-R7 24T2643 24T2643-R4 24T2643-R7 24T2653 24T2673 24T2673-R4

Refer to www.specselect.com for individual models.

Flow Rates are at 60 PSI.
Note: Use this page front and back as a product submittal sheet.

Delta reserves the right (1) to make changes in specifications and materials, and (2) to change or discontinue models, both without notice or obligation. Dimensions are for reference only. See current full-line price book or www.specselect.com for finish options and product availability.



DSP-24T Rev. J

Single Control Widespread Faucet

TECK
COMMERCIAL

DELTA

APPROVALS:

- CSA certified
- Complies to ASME A112.18.1/CSA B125.1
- For commercial use only
-  Indicates compliance to ICC/ANSI A117.1
-  Outlet options 2, 3, 4 and 7 are EPA WaterSense listed
- Verified compliant with 0.25% weighted average Pb content regulations

(Contact Delta Representative for State and/or Local Approvals.)

FLOW RATE vs PRESSURE

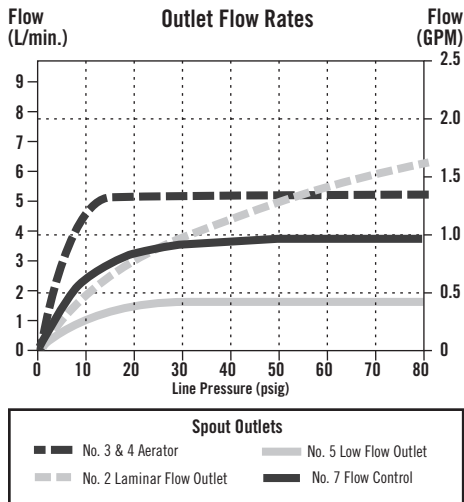

- **24T0003**
Control Unit Only with 6" Handle

FOR OPTIONAL RIGID/SWIVEL & LIMITED SWING SPOUTS

See **DSP-R/S** for detailed specification.

Note: Measurements may vary ± 6mm (0.25")

Refer to www.specselect.com for individual models.

GOOSENECK

Outlets #2, 3, 4, 5

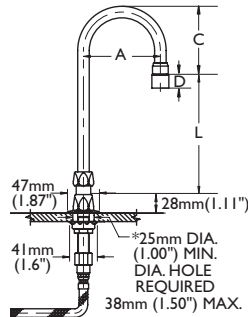

Outlet #7

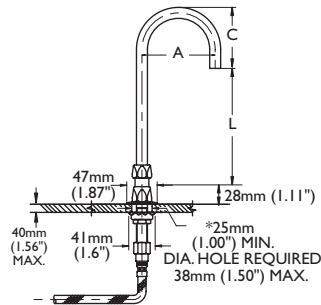

CONTROL UNIT

No. 3 Handle

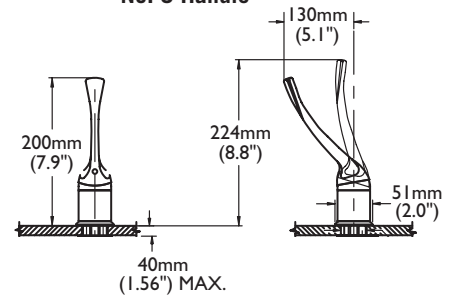

INLET FOR 3/8" OR 1/2" FLEXIBLE RISER OR 1/2-14 NPSM COUPLING NUT (NOT SUPPLIED)

HANDICAP INSTALLATION

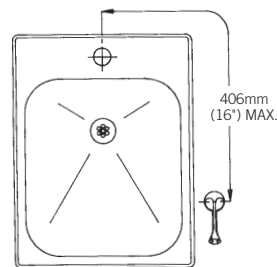

GOOSENECK SPOUT ASSEMBLIES

SPOUT/OUTLET	"A"		"C"		"L"	
	mm	in.	mm	in.	mm	in.
Gooseneck-Standard (R2) for outlets #2, 3, 4 & 5	114	4.5	104	4.1	170	6.7
Gooseneck-Standard (R2) for outlet #7	114	4.5	97	3.8	178	7.0

GOOSENECK SPOUT OUTLET NO.	"D"	
	mm	in.
2	18	0.45
3	11	0.45
4	11	0.45
5	11	0.45

Note: Use this page front and back as a product submittal sheet.